



# SEADEC

---

**SEADEC DOORS** bring warmth, style and prestige to your home and have been the chosen brand for designers, architects and homeowners for many years. Our bespoke range of doors and finishes have been specially selected for the Irish market covering modern, contemporary and traditional styles. Our large selection of doors are available in eight standard sizes which makes choosing a door that's right for your project easy. We also stock an extended range of metric sizes for Fire Doors. Our range of door frames, skirting and architrave are designed to complement each collection for a flawless designer look.

We are committed to sourcing all our doors and mouldings from well managed and sustainable sources. Our company has achieved both FSC® and PEFC Chain of Custody certification and all doors are made to the highest industry standards using quality materials that stand the test of time. We are an Irish owned company and our products are available nationwide from all leading builders providers, DIY, furniture, flooring and door stores.





# seadec

doors for living...

WHITE PRIMED DOORS	<b>04</b>
WHITE PRIMED GLASS OPTIONS	<b>14</b>
WHITE PRIMED DESIGN	<b>16</b>
WHITE PRIMED DESIGN GLASS	<b>21</b>
EXCLUSIVE GREY RANGE	<b>20</b>
OAK DOORS	<b>24</b>
OAK GLASS OPTIONS	<b>33</b>
WALNUT DOORS	<b>34</b>
WALNUT GLASS OPTIONS	<b>38</b>
BESPOKE DESIGN RANGE	<b>43</b>
GLASS DESIGN RANGE	<b>45</b>
RED PINE DOORS	<b>46</b>
RED PINE GLASS OPTIONS	<b>49</b>
REGENCY DOORS	<b>52</b>
FIRE DOORS	<b>56</b>
FIRE DOOR GLASS OPTIONS	<b>62</b>
WHITE PRIMED MOULDINGS	<b>64</b>
OAK & WALNUT MOULDINGS	<b>68</b>
DOOR SIZES & SPECIFICATIONS	<b>72</b>
CARE AND INSTALLATION GUIDE	<b>74</b>
HOW TO FINISH A WHITE PRIMED DOOR	<b>75</b>

# WHITE PRIMED DOORS

---

**WHITE PRIMED DOORS** allow you create a relaxing and classical finish to your home. These doors have laminated solid timber stiles for stability and MDF cover panels for a smooth consistent finish. The white primed finish provides a good base for finishing coats. White primed engineered doors achieve a smoother finish than traditional timber doors and eliminate the transfer of wood grain.

WHITE PRIMED

Seadec

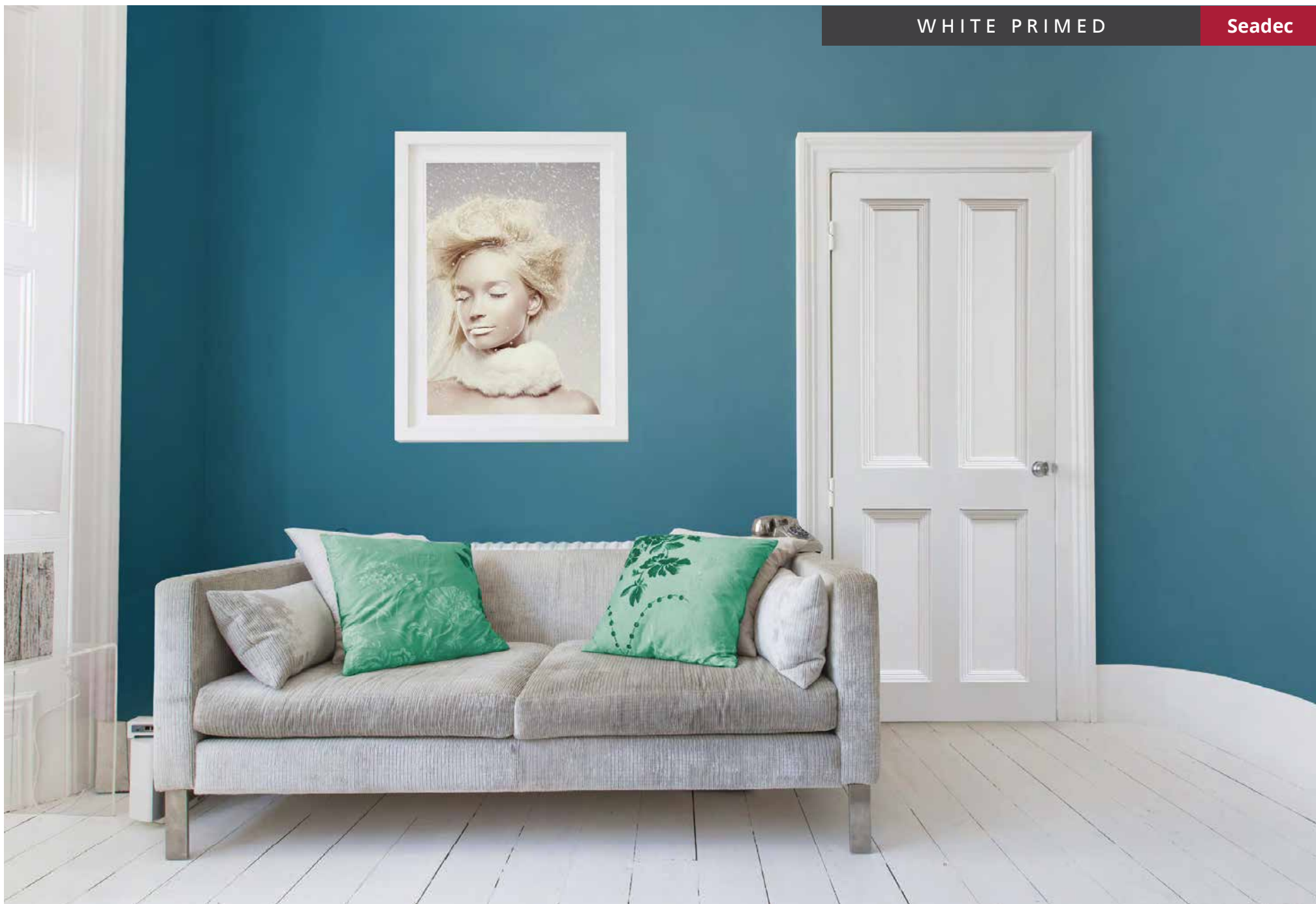



WHITE PRIMED

Seadec

AVAILABLE IN CLEAR GLASS



**ARIZONA WHITE**  
9 PANEL PRE-GLAZED  
FLAT CLEAR GLASS



**CAMBRIDGE WHITE**  
4 PANEL



**OXFORD WHITE**  
TOP 2 PANEL UNGLAZED



**NEVADA WHITE**  
SHEETED

ALSO AVAILABLE IN PLAIN CLEAR GLASS

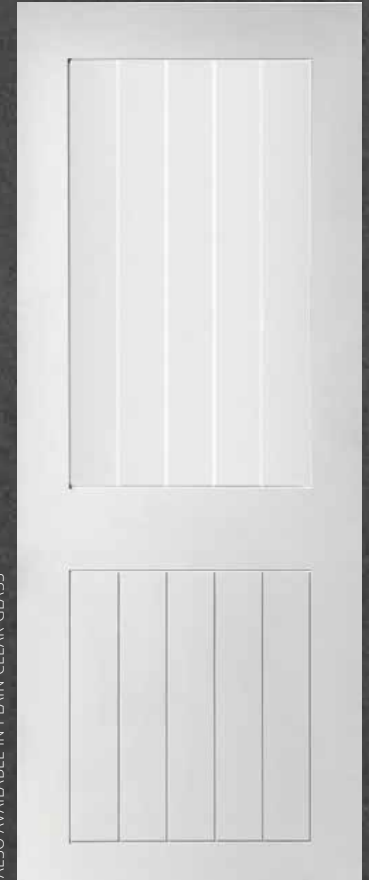

**NEVADA WHITE**  
FROSTED PRINTED GLASS WITH  
VERTICAL CLEAR LINES

42  
MM



**WHITE PRIMED DOORS** can provide both traditional and modern designs to enhance any home, we have now increased the selection of designs that are available in our white primed range. The beauty of white primed doors is that you can customise the finishing colour to your liking, the white primed finish provides an excellent base for finishing coats.







**KINGSCOURT WHITE**  
4 PANEL



**WATERFORD WHITE**  
TOP 2 PANEL UNGLAZED



**HAMPTON WHITE**  
1 PANEL SHAKER



**CHESHIRE WHITE**  
1 PANEL SHAKER PRE-GLAZED



**CHESHIRE WHITE**  
1 PANEL SHAKER PRE-GLAZED  
FROSTED WITH 30MM CLEAR BORDER

AVAILABLE IN CLEAR OR FROSTED PRINTED GLASS



**WHITE PRIMED DOORS** can provide both traditional and modern designs to enhance any home, we have now increased the selection of designs that are available in our white primed range. The beauty of white primed doors is that you can customise the finishing colour to your liking, the white primed finish provides an excellent base for finishing coats.





**AUGUSTA WHITE**  
4 PANEL SHAKER

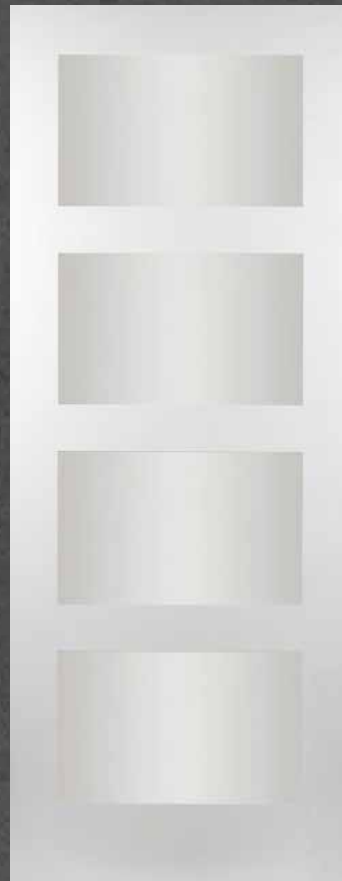

AVAILABLE IN CLEAR OR FROSTED PRINTED GLASS

**COLUMBUS WHITE**  
4 PANEL GLAZED



AVAILABLE IN CLEAR OR FROSTED PRINTED GLASS

**ALBANY BOLECTION**  
2 PANEL GLAZED



**KINGSTON BOLECTION**  
2 PANEL RAISED



**WHITE PRIMED DOORS** can provide both traditional and modern designs to enhance any home, we have now increased the selection of designs that are available in our white primed range. The beauty of white primed doors is that you can customise the finishing colour to your liking, the white primed finish provides an excellent base for finishing coats.





**TRENTON WHITE**  
1 PANEL SHAKER STEPPED



AVAILABLE IN CLEAR OR FROSTED PRINTED GLASS

**MADISON WHITE**  
1 PANEL SHAKER STEPPED



**SUSSEX**  
5 PLANK COTTAGE

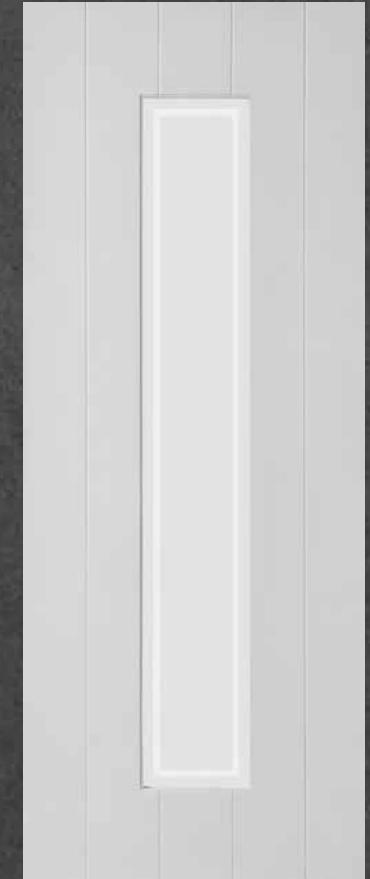

**SOMERSET**  
PRINTED FROSTED GLASS  
WITH 30MM CLEAR  
BORDER



**WHITE PRIMED DOORS** can provide both traditional and modern designs to enhance any home, we have now increased the selection of designs that are available in our white primed range. The beauty of white primed doors is that you can customise the finishing colour to your liking, the white primed finish provides an excellent base for finishing coats.



# WHITE PRIMED GLASS OPTIONS

Our glass doors can be supplied in clear glass or flemish glass in all the designs shown on this page. Flemish glass offers a higher level of privacy as it reduces the glass visibility.



**WATERFORD**  
2 PANEL - GLASS TYPE 3



**WATERFORD**  
2 PANEL - GLASS TYPE 4



**WATERFORD**  
2 PANEL - GLASS TYPE 5



**WATERFORD**  
2 PANEL - GLASS TYPE 6



**WATERFORD**  
2 PANEL - GLASS TYPE 1



**WATERFORD**  
2 PANEL - GLASS TYPE 2



**OXFORD WHITE**  
2 PANEL - GLASS TYPE 3



*Clear Glass*

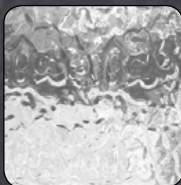

*Flemish Glass*

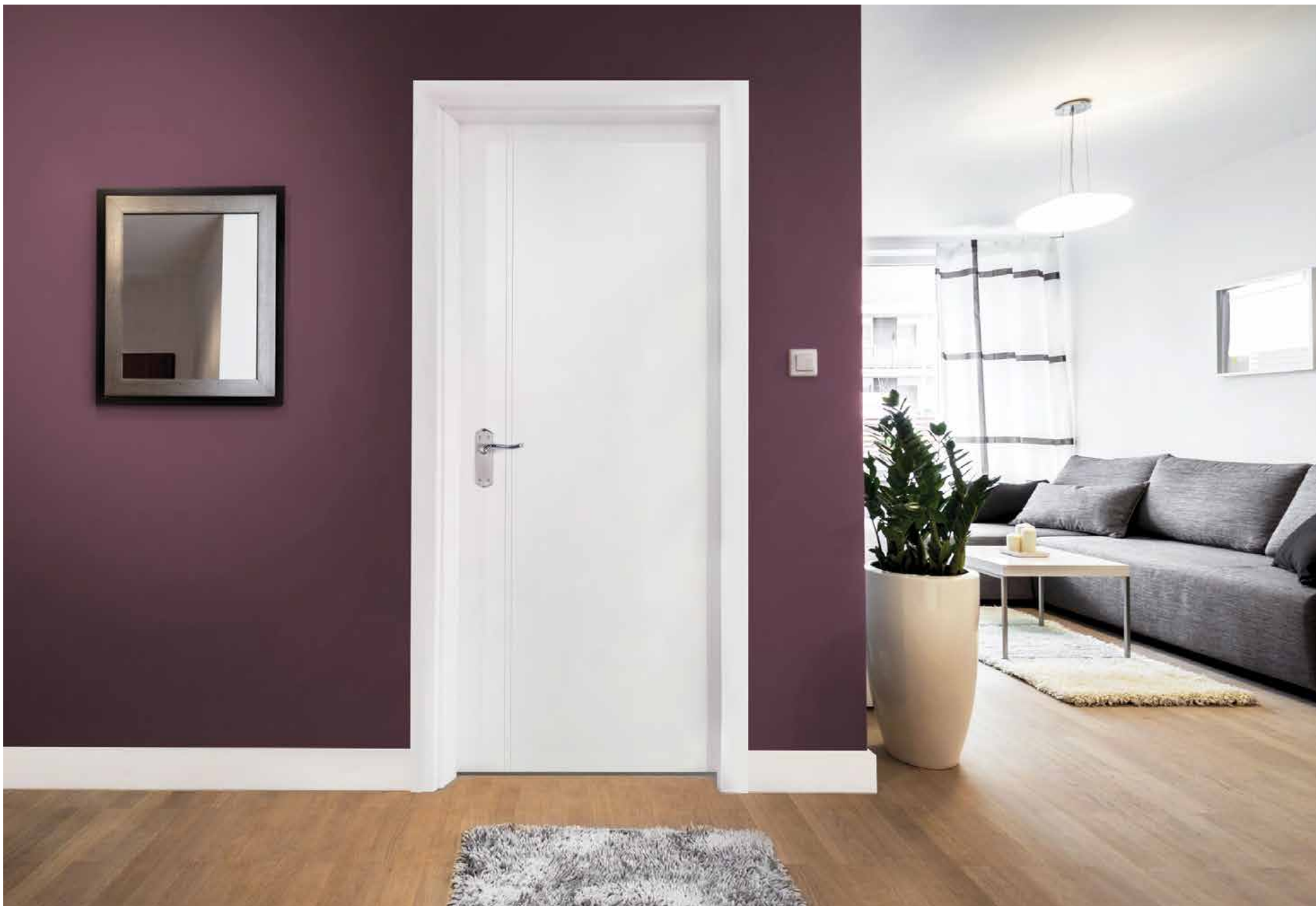



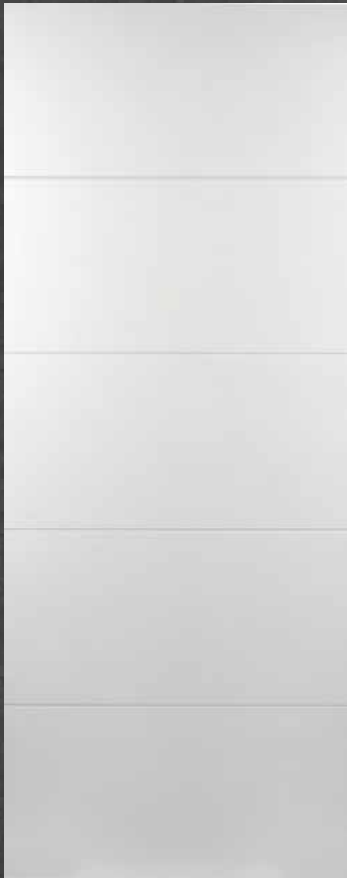

**COLORADO WHITE**  
5 PANEL



**DAKOTA WHITE**  
4 VERTICAL LINES



**IDAHO WHITE**  
2 VERTICLE LINES



**UTAH WHITE**  
LADDER EFFECT

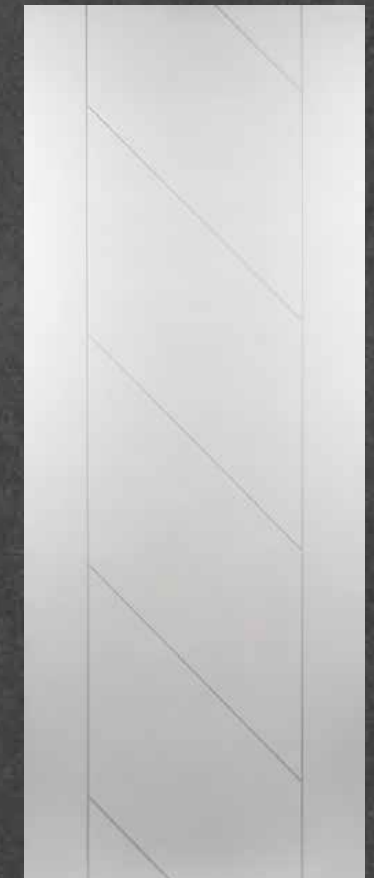

**OHIO WHITE**  
HORIZONTAL LADDER



**WHITE PRIMED DOORS** can provide both traditional and modern designs to enhance any home, we have now increased the selection of designs that are available in our white primed range. The beauty of white primed doors is that you can customise the finishing colour to your liking, the white primed finish provides an excellent base for finishing coats.



18 DELAWARE (DFG41) SINGLE PANEL GLASS

ALL DOORS ARE AVAILABLE IN CLEAR OR FROSTED EFFECT GLASS



**DELAWARE (DFG41)**  
SINGLE PANEL GLASS

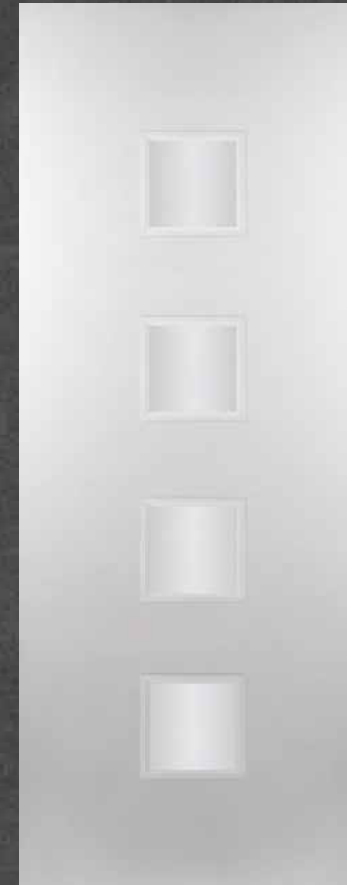

**MARYLAND (DFG20)**  
4 SQUARE PANELS

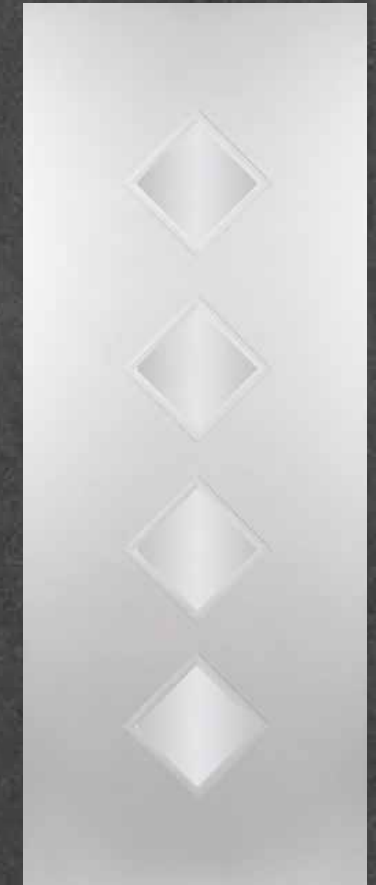

**ALASKA (DFG75)**  
4 DIAMOND PANELS



**WHITE PRIMED DOORS** can provide both traditional and modern designs to enhance any home, we have now increased the selection of designs that are available in our white primed range. The beauty of white primed doors is that you can customise the finishing colour to your liking, the white primed finish provides an excellent base for finishing coats.

# EXCLUSIVE GREY RANGE

---

**EXCLUSIVE GREY RANGE** In the world of interior design, there's no hotter colour than grey. Although it might sound dull, styling your home with grey tones instantly adds a classy and chic finish to any room, and even though it's been used for a few years now, grey is a trend that isn't going away.





*Exclusive Grey range available from October 2018*



**GENOA**



**NAPOLI**  
CLEAR OR FROSTED GLASS



**GENOA**  
RAISED FEATURE



**MILANO GREY**  
V GROOVE JOINT



**MILANO GREY**  
GRAINED

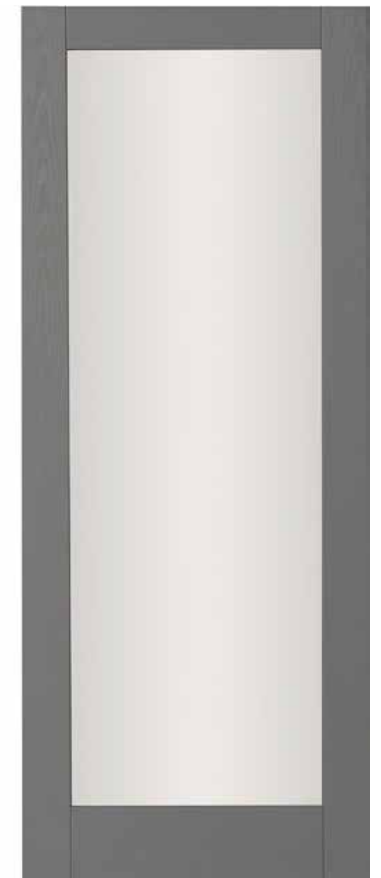

**TORINO GREY**  
CLEAR OR FROSTED GLASS



**EXCLUSIVE GREY RANGE** The Milano and Torino Oak Grained Grey internal door is guaranteed to add character to your room and complement your existing interior decor. The intricate pattern of the Oak Grain creates a truly unique design, adding to the quality appearance of the door and creating a striking central feature. The raised inset feature of the Genona and Napoli doors will add a designer look and style to any surroundings creating a look that is unique in todays market.

# OAK DOORS

---

**WHITE OAK DOORS** remain very popular both in traditional and contemporary ranges due to their rich finish. White primed skirting and architrave finished to contrast with oak door is becoming a bespoke finish. The beauty of oak is that it can be finished with complementary oak mouldings or contrasted.



*All Seadec oak doors come prefinished with high performance Crystal Shield*

*\*Seadec doors are natural products and we cannot guarantee the brochure colours will be an exact match to the actual product. Selection prior to fitting is the sole responsibility of the installer and end user.*



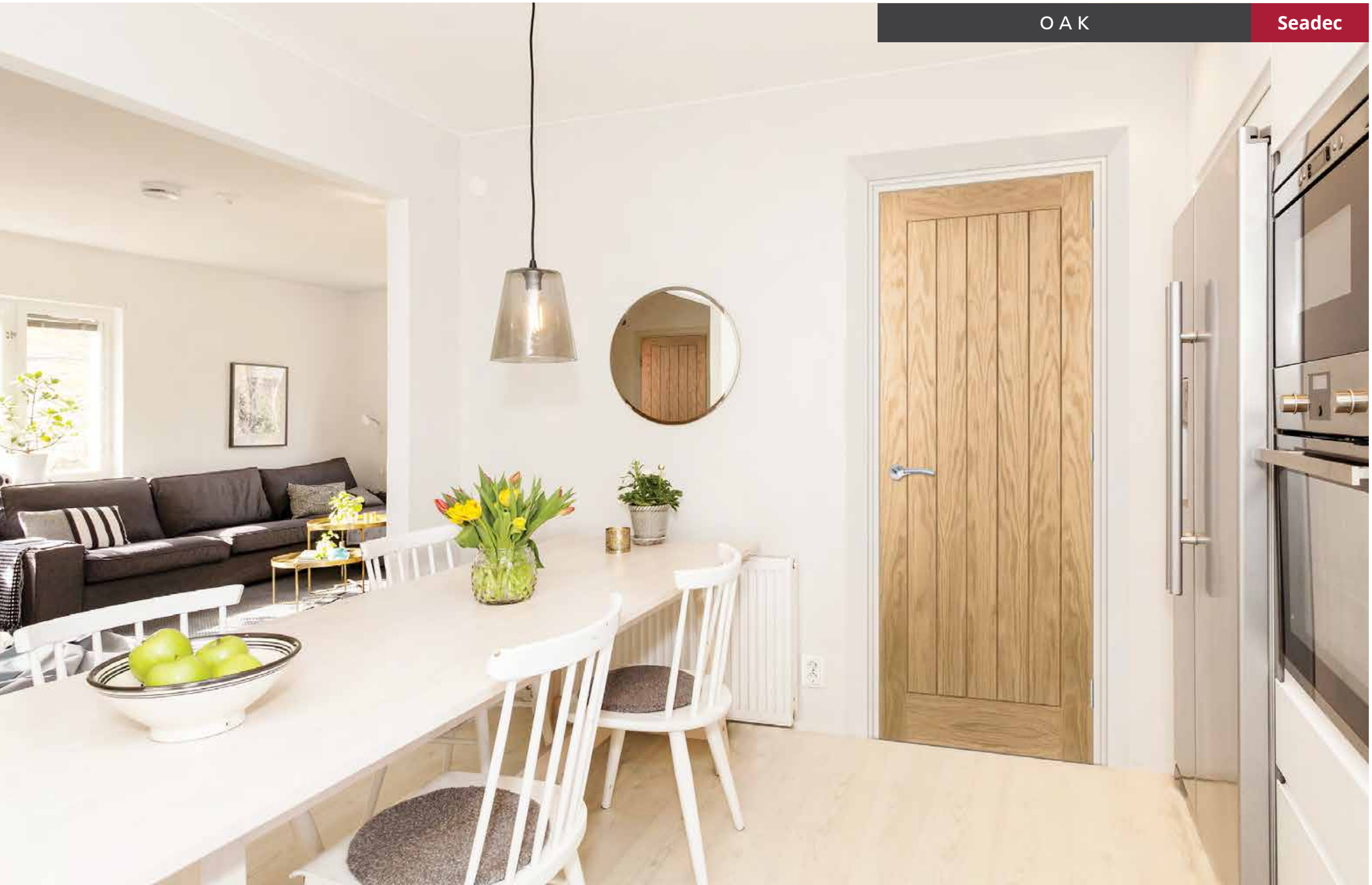



**ARIZONA OAK**  
9P CLEAR BEVEL GLASS



**NEVADA OAK**  
SHEETED



**HAMPTON OAK**  
1 PANEL SHAKER



AVAILABLE IN CLEAR OR FROSTED LAMSAFEG GLASS

**CHESHIRE OAK**  
1 PANEL SHAKER PRE-GLAZED



**AUGUSTA OAK**  
4 PANEL SHAKER



AVAILABLE IN CLEAR OR FROSTED LAMSAFEG GLASS

**COLUMBUS OAK**  
4 PANEL SHAKER PRE-GLAZED



**WHITE OAK** provides a richness that is hard to beat for your home. Our white oak doors are made to highest standards using American white oak veneers. All our Seadec oak doors come with crystal shield lacquer which provides a superior finish that can be easily appreciated when you touch our doors.





**WESTPORT OAK**  
6 PANEL



**KINGSCOURT OAK**  
4 PANEL



**BELFAST OAK**  
4 PANEL CURVED



**WATERFORD OAK**  
2 TOP PANEL UNGLAZED



**LONGFORD OAK**  
2 TOP PANEL CURVED UNGLAZED



**WHITE OAK** provides a richness that is hard to beat for your home. Our white oak doors are made to highest standards using American white oak veneers. All our Seadec oak doors come with crystal shield lacquer which provides a superior finish that can be easily appreciated when you touch our doors.





**KINGSTON OAK**  
2 PANEL



AVAILABLE IN CLEAR OR FROSTED LAMSAFEG GLASS

**ALBANY OAK**  
2 PANEL PRE-GLAZED



**OAK BOLECTION**  
4 PANEL CURVED



**OAK BOLECTION**  
2 PANEL CURVED UNGLAZED



**OAK BOLECTION**  
2 PANEL CURVED - GLASS TYPE 3



**OAK BOLECTION DOORS** provide added elegance with raised mould features. Our white oak doors are made to highest standards using American white oak veneers. All our Seadec oak doors come with crystal shield lacquer which provides a superior finish that can be easily appreciated when you touch our doors.



32 LONGFORD OAK BOLECTION GLASS 3



**OAK BOLECTION**  
2 PANEL CURVED - GLASS 5



**OAK BOLECTION**  
2 PANEL CURVED - GLASS 6



# OAK GLASS OPTIONS

Our glass doors can be supplied in clear glass or flemish glass in all the designs shown on this page. Flemish glass offers a higher level of privacy as it reduces the glass visibility.



**LONGFORD OAK**  
2 PANEL - GLASS TYPE 3



**LONGFORD OAK**  
2 PANEL - GLASS TYPE 4



**LONGFORD OAK**  
2 PANEL - GLASS TYPE 5



**LONGFORD OAK**  
2 PANEL - GLASS TYPE 6



**WATERFORD OAK**  
2 PANEL - GLASS TYPE 1



**WATERFORD OAK**  
2 PANEL - GLASS TYPE 2



**WATERFORD OAK**  
2 PANEL - GLASS TYPE 3

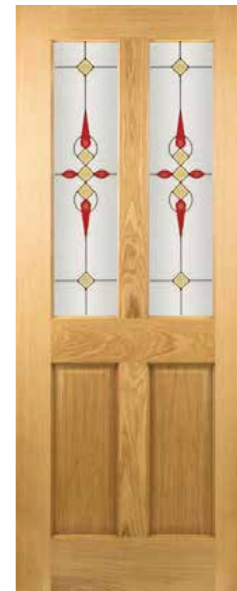

**WATERFORD OAK**  
2 PANEL - GLASS TYPE 4



**WATERFORD OAK**  
2 PANEL - GLASS TYPE 5



**WATERFORD OAK**  
2 PANEL BEVELLED - GLASS TYPE 6

# WALNUT DOORS

---

**WALNUT DOORS** Our walnut doors are constructed with a real wood veneer over solid wood stiles and rails. A solid 15mm slip on each side gives a rebating option. Pre-finished to a high standard, Seadec's walnut doors have the look and feel of pure quality. White primed skirting and architrave can be used to contrast with walnut doors and is becoming a popular bespoke finish. Alternatively it can be finished with matching complementary walnut mouldings.



*All Seadec walnut doors come prefinished with high performance Crystal Shield*

*\*Seadec doors are natural products and we cannot guarantee the brochure colours will be an exact match to the actual product. Selection prior to fitting is the sole responsibility of the installer and end user.*

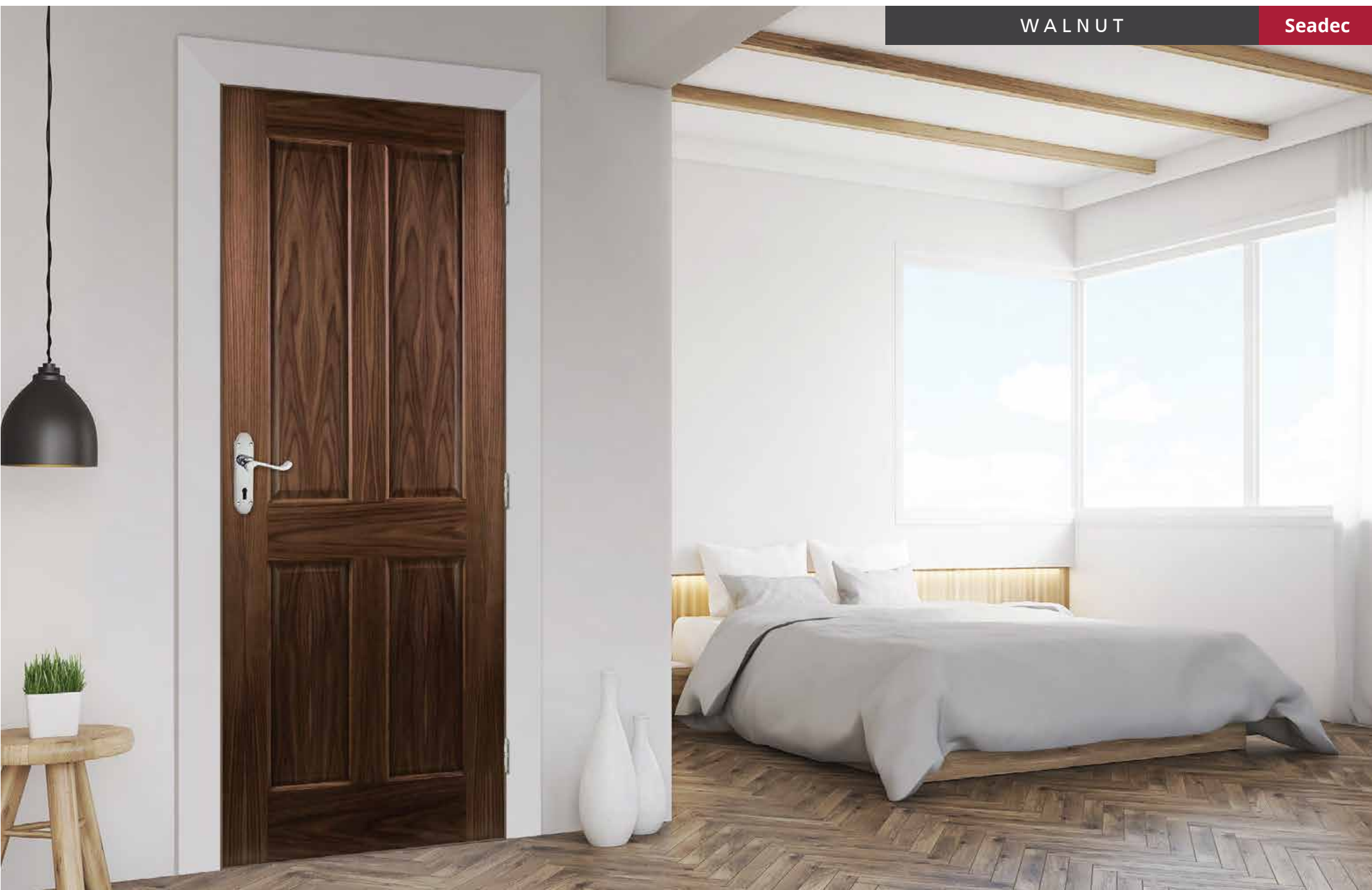



AUGUSTA WALNUT 4 PANEL SHAKER



**AUGUSTA WALNUT**  
4 PANEL SHAKER



AVAILABLE IN CLEAR OR FROSTED LAMSAFEG GLASS

**COLUMBUS WALNUT**  
4 PANEL SHAKER PRE-GLAZED



**KINGSCOURT WALNUT**  
4 PANEL



**WATERFORD WALNUT**  
2 TOP PANELS UNGLAZED



**ARIZONA WALNUT**  
9P CLEAR BEVEL GLASS



**HAMPTON WALNUT**  
1 PANEL SHAKER



**CHESHIRE WALNUT**  
1 PANEL SHAKER PRE-GLAZED

AVAILABLE IN CLEAR OR FROSTED LAMSAFEG GLASS



**SEADec WALNUT DOORS** provide a deep richness that is hard to beat, our doors are made using only the finest American walnut veneers. Our walnut doors also come with solid American walnut lippings, many competing walnut doors use tropical hardwood with stain cover. All our Seadec walnut doors also come with our crystal shield lacquer which provides a superior finish that can be easily appreciated when you touch our doors.

# WALNUT GLASS OPTIONS

---

Our glass doors can be supplied in **clear glass** or **flemish glass** in all the designs shown on these page. Flemish glass offers a higher level of privacy as it reduces the glass visibility.

WATERFORD WALNUT 2 PANEL- GLASS TYPE 1





**WATERFORD WALNUT**  
2 PANEL GLASS TYPE 1

**WATERFORD WALNUT**  
2 PANEL GLASS TYPE 2

**WATERFORD WALNUT**  
2 PANEL GLASS TYPE 3

**WATERFORD WALNUT**  
2 PANEL GLASS TYPE 5

**WATERFORD WALNUT**  
2 PANEL GLASS TYPE 6



**SEADec WALNUT DOORS** provide a deep richness that is hard to beat, our doors are made using only the finest American walnut veneers. Our walnut doors also come with solid American walnut lippings, many competing walnut doors use tropical hardwood with stain cover. All our Seadec walnut doors also come with our crystal shield lacquer which provides a superior finish that can be easily appreciated when you touch our doors.

# BESPOKE DESIGN RANGE

Design Range is available in seven bespoke colour finishes - White Primed, Walnut, Ebony, Mocha, Oak, Oak White and Porpoise with a choice of five contemporary designs to choose from.

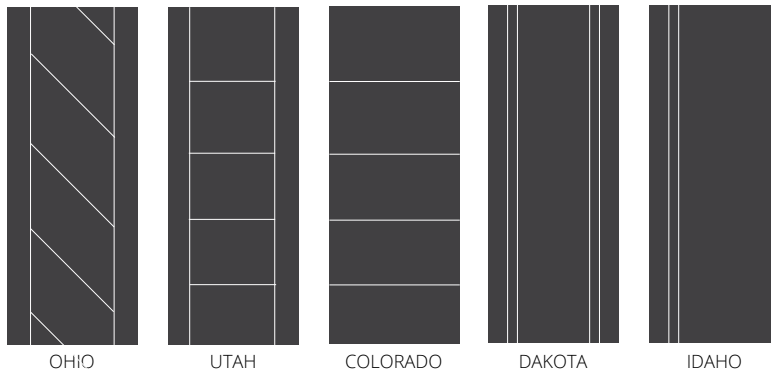

Also available flush with no grooves / design.



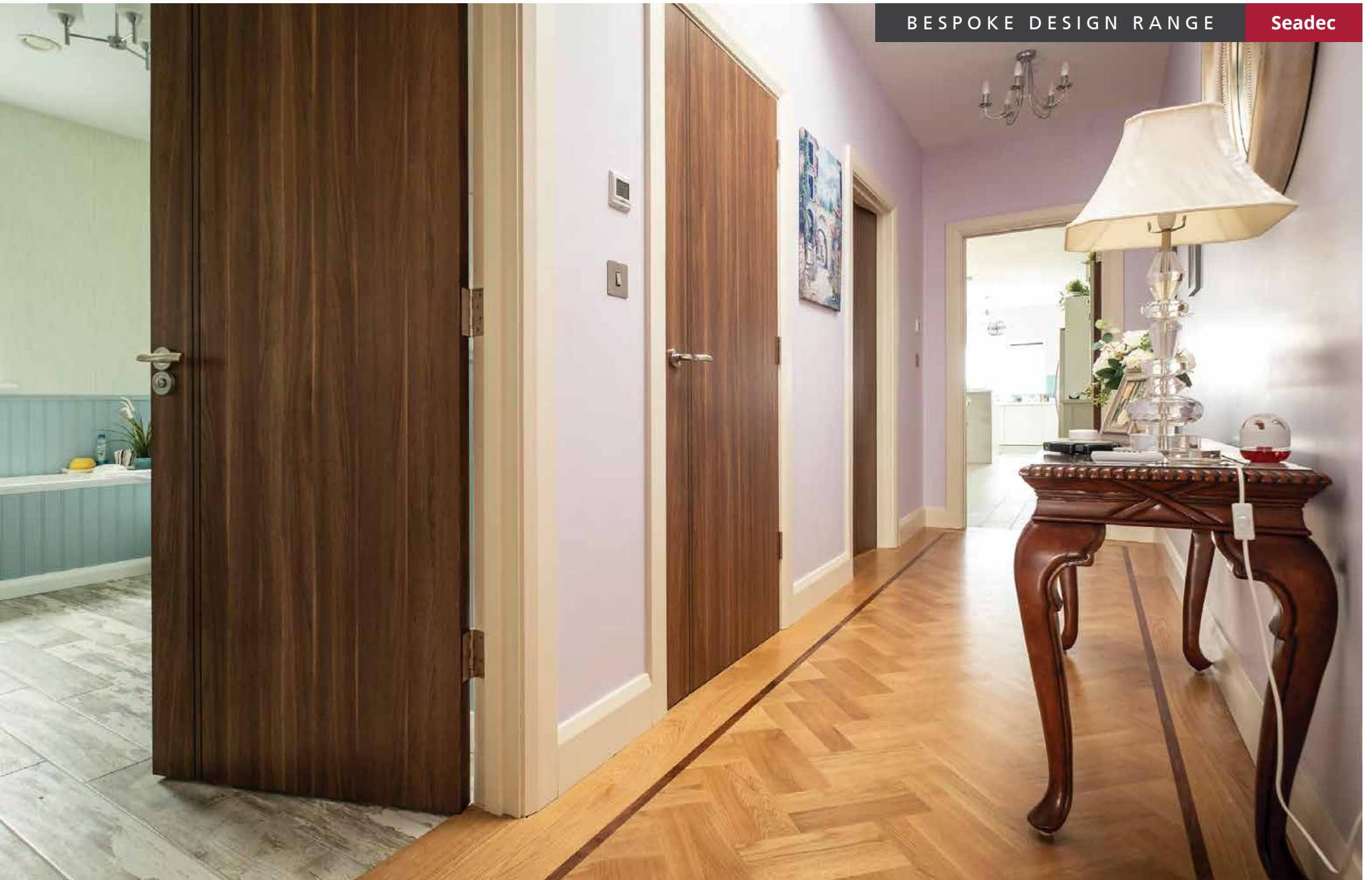

# YOUR BESPOKE DESIGN

## 1 *pick design*

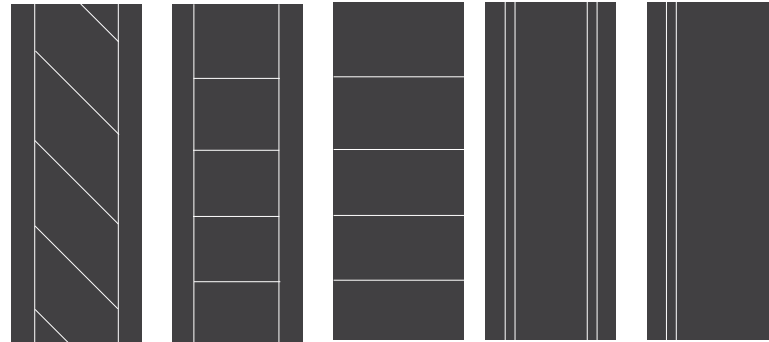

OHIO

UTAH

COLORADO

DAKOTA

IDAHO

Also available flush with no grooves / design.

## 2 *pick colour*



OAK EBONY

OAK WHITE

OAK MOCHA

OAK PORPOISE

OAK

WALNUT DEKORDOR

Also available in white primed - see page 17



**WALNUT**  
WITH IDAHO DESIGN



**EBONY**  
WITH OHIO DESIGN



**MOCHA**  
WITH COLORADO DESIGN



**OAK WHITE**  
WITH DAKOTA DESIGN



**PORPOISE**  
WITH UTAH DESIGN



**DESIGN RANGE** offers the ultimate choice in modern colours and contemporary design. Our new range allows you to build the look you desire, its simple order in smooth colour finish or add one of the concept designs to your colour. *Orders from our design range are custom made so please allow 3 weeks delivery time. This range comes as standard with a FD30 fire rating.*

# GLASS DESIGN RANGE

---

Our glass design range is complemented with three glass design options. Glass doors can be ordered in seven different colours within the design range and concept designs can also be added. These glass designs come with toughened glass but are non fire rated - please see our fire door section for information on fire rated glass designs.

Please allow 3-4 weeks for delivery of your bespoke order.



YOUR **BESPOKE DESIGN** CAN BE GOT **WITH EASE**

- 1 pick glass design
- 2 pick your colour
- 3 pick your design - flush or grooved



DELAWARE (DFG41)



MARYLAND (DFG20)



ALASKA (DFG75)



OAK EBONY



OAK WHITE



OAK MOCHA



OAK PORPOISE

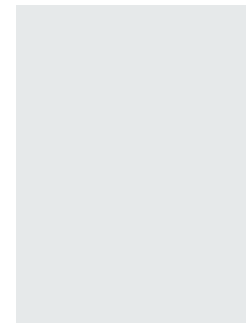

WHITE PRIMED



OAK



WALNUT DEKORDOR

# RED PINE DOORS

---

**RED PINE DOORS** Tradition always stands the test of time. Our pine door range brings the warmth of tradition into your home. They come prefinished with clear lacquer and have a high quality construction. The range is complimented by several pre glazed options allowing you to create a relaxing and classical finish to your home.

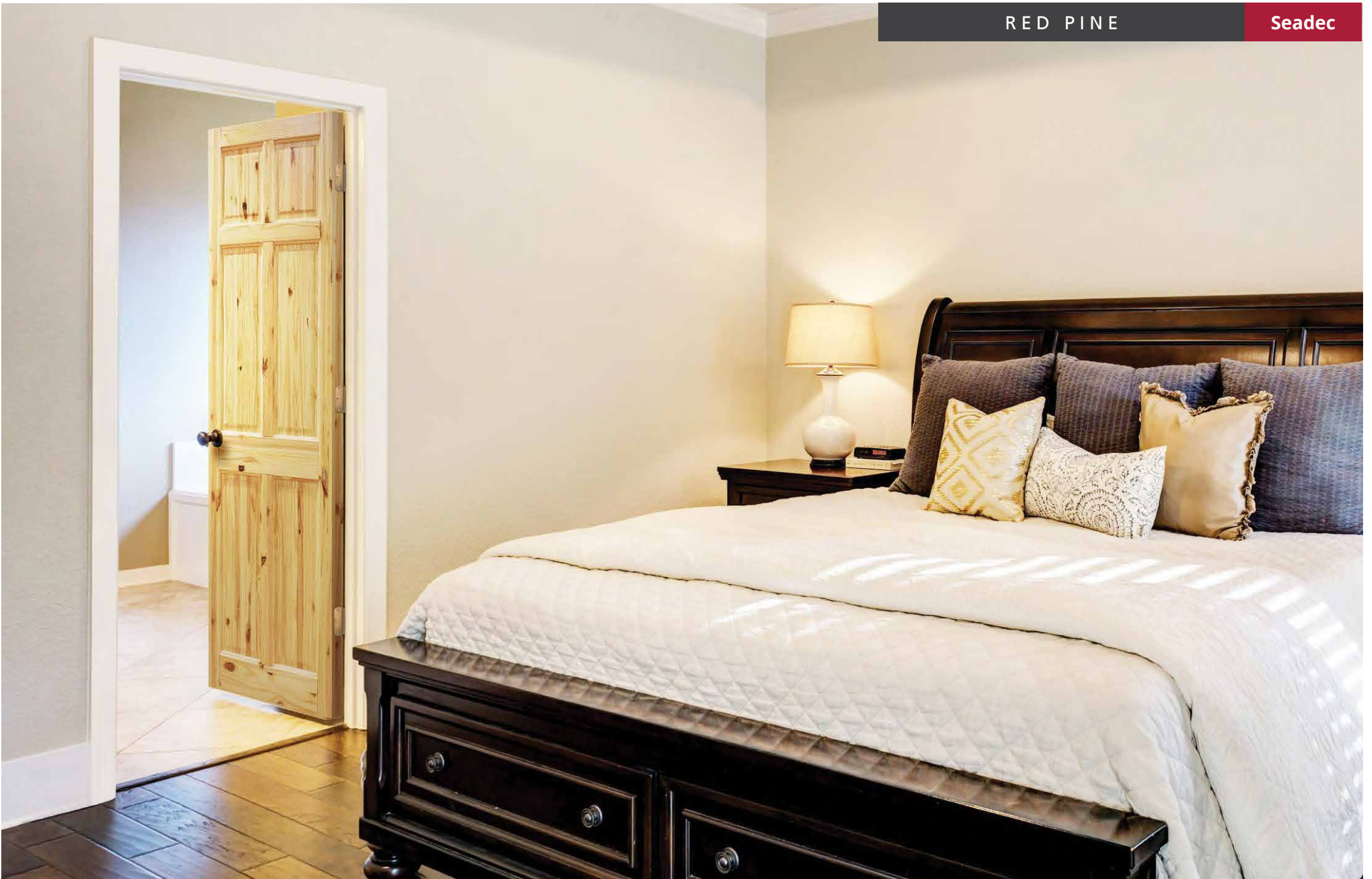



48 WESTPORT RED PINE 6 PANEL



BELFAST RED PINE 4 PANEL CURVED





**WESTPORT RED PINE**  
6 PANEL



**KINGSCOURT RED PINE**  
4 PANEL



**WATERFORD RED PINE**  
2 PANEL - UNGLAZED



**BELFAST RED PINE**  
4 PANEL - CURVED



**LONGFORD RED PINE**  
2 PANEL CURVED - UNGLAZED



**RED PINE DOORS** provide a traditional finish for your home that is timeless and allows the character of wood to shine through, red pine doors also come with an elegant V-groove design on the joints.

# RED PINE GLASS OPTIONS

---

Our glass doors can be supplied in clear glass or flemish glass in all the designs shown on these pages. Flemish glass offers a higher level of privacy as it reduces the glass visibility. We can also supply Waterford or Longford in plain clear glass.





Clear Glass

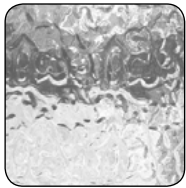

Flemish Glass



**LONGFORD PINE**  
2 PANEL - GLASS TYPE 3



**LONGFORD PINE**  
2 PANEL - GLASS TYPE 4



**LONGFORD PINE**  
2 PANEL - GLASS TYPE 5

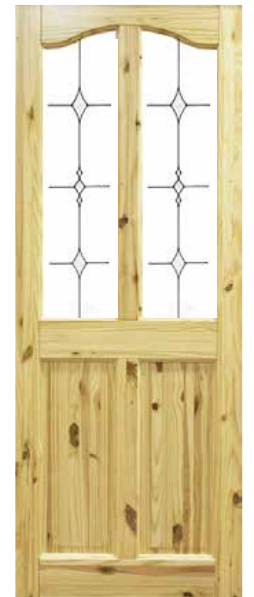

**LONGFORD PINE**  
2 PANEL - GLASS TYPE 6



**WATERFORD PINE**  
2 PANEL - GLASS TYPE 1



**WATERFORD PINE**  
2 PANEL - GLASS TYPE 2



**WATERFORD PINE**  
2 PANEL - GLASS TYPE 3



**WATERFORD PINE**  
2 PANEL - GLASS TYPE 4



**WATERFORD PINE**  
2 PANEL - GLASS TYPE 5



**WATERFORD PINE**  
2 PANEL - GLASS TYPE 6

# REGENCY DOORS

---

**REGENCY DOORS** are made with a wood fibre press panel, which provides an elegant range of designs to choose from. Regency doors are unfinished and must be finished on site. It is very important that the doors are sealed immediately after they are brought to site for installation. It is important to also to seal the top and the bottom of the door.

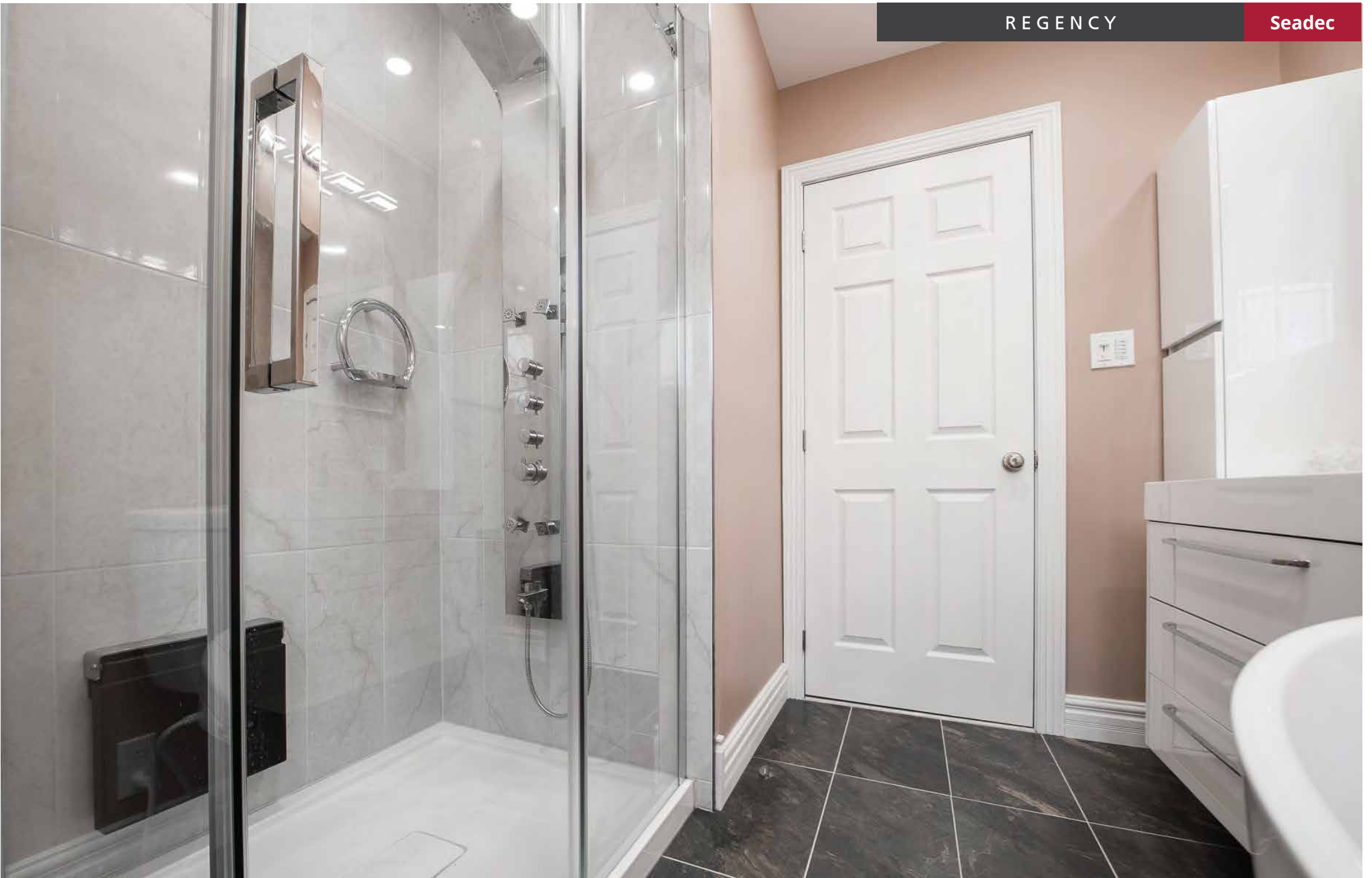

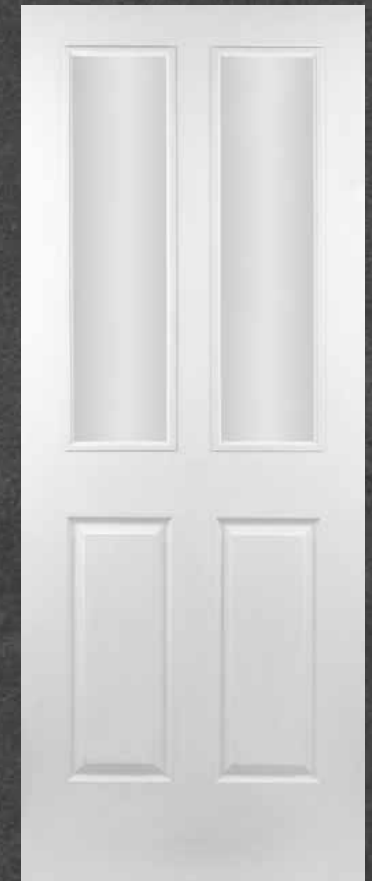

**2P/2L WOOD GRAIN**  
CLEAR GLASS



6 PANEL WOOD GRAIN



4 PANEL WOOD GRAIN



2 PANEL WOOD GRAIN



6 PANEL SMOOTH



2 PANEL SMOOTH



Regency doors are made with a wood fibre press panel, which provides an elegant range of designs to choose from. Regency doors are unfinished and must be finished on site. It is very important that the doors are sealed immediately after they are brought to site for installation. It is important to also to seal the top and the bottom of the door.

# FIRE DOORS

---

**FIRE DOORS** Seadec offer a select range of doors in FD30 to complement our existing door range. All of our fire doors are fully accredited by Fire Test Assessment reports, which are available on request and provide detailed information on the door's scope of use. It is essential that fire doors are fitted in accordance with the certification which will also explain specification of door frame, intumescent materials and ironmongery. All Seadec white primed and oak fire doors are FSC® certified.



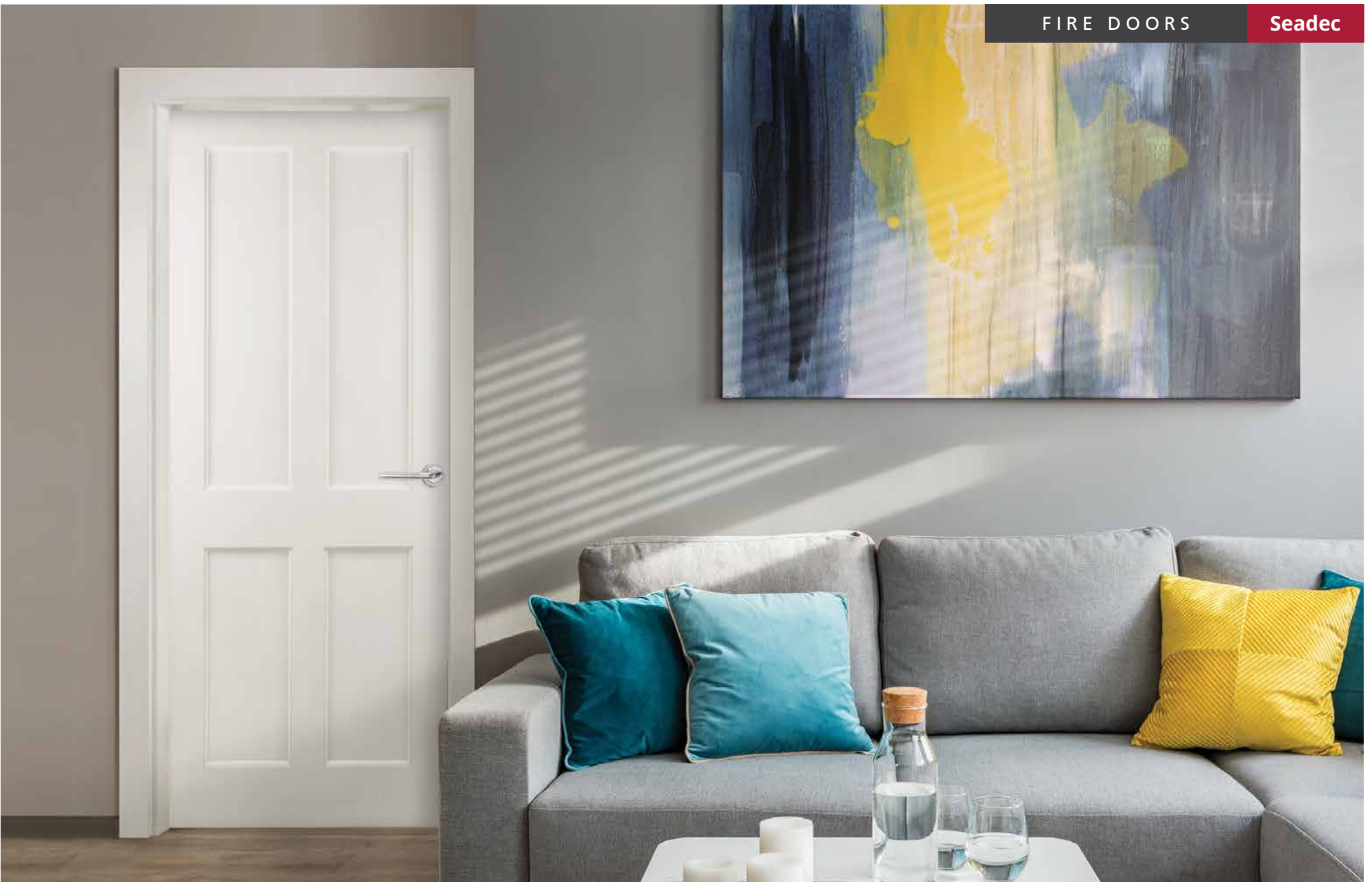

We now offer a select range of white primed, oak and walnut doors in FD30 (30 minute rating) to complement our existing door range. All of our fire doors are fully accredited by Fire Test Assessment reports, which are available on request and provide detailed information on the door's scope of use. It is essential that fire doors are fitted in accordance with the certification which will also explain specification of door frame, intumescent materials and ironmongery.

All Seadec oak and primed fire doors are FSC® certified.



The mark of responsible forestry



**FD30 FIREDOOR  
CHESHIRE OAK**  
1 PANEL SHAKER PRE-GLAZED



**FD30 FIREDOOR  
KINGSCOURT OAK**  
4 PANEL



**FD30 FIREDOOR  
HAMPTON OAK**  
1 PANEL SHAKER



**FD30 FIREDOOR  
HAMPTON WALNUT**  
1 PANEL SHAKER



**FD30 FIREDOOR  
KINGSCOURT WHITE**  
4 PANEL



**FD30 FIREDOOR  
HAMPTON WHITE**  
1 PANEL SHAKER



**FD30 FIREDOOR  
CHESHIRE WHITE**  
1 PANEL PRE-GLAZED



**FD30 FIREDOOR  
KINGSTON BOLECTION**  
2 PANEL RAISED



**FD30 FIREDOOR  
TRENTON WHITE**  
1 PANEL SHAKER STEPPED

# FIRE DOORS



Vicaima are European leaders in Fire doors and their reputation has been built on quality of product. All Vicaima doors are backed up by certification from BWF Certifire and BM Trada Q mark. All fire doors are supported by fully accredited Fire Test Assessment reports, It is essential that fire doors are fitted in accordance with the certification which will also explain the specification of door frame, intumescent materials and ironmongery. All Vicaima doors are FSC® certified as standard. Veneered finished doors have 2 coats of high quality UV clear acrylic satin finish - this finish provides a smooth surface to the door enhancing the natural beauty of the veneer. Our Walnut door is from the Dekordor foil range which provides a man-made finish that allows for excellent matching. Lippings are supplied unfinished on the Dekordor range and must be sealed on site with clear polyurethane finish. FD30 and FD60 fire doors are available in all models. Glazing options - we can offer clear glass in FD30 or FD60 and GWPP safety glass in FD30.

## *Stay Safe with Vicaima Fire Door Solutions*

- Tests as per EN and BS Standards
- Fire doors certified by accredited laboratories
- CE Marked ironmongery
- Factory approved glazing
- Bespoke design and dimensions
- Doors, Kits or Sets
- Acoustic and Security Options



**FD30 / FD60**  
FIRE RATING



**THERMAL**  
TRANSMISSION



**HIGH**  
DURABILITY



**ANTIL SMOKE**  
SEAL



**MOBILITY**  
SUITABLE





**FD30 FIRE DOOR  
MDF PAINT GRADE**  
UNFINISHED & SANDED



**FD30/FD60 FIRE DOOR  
OAK UNIVERSAL**  
PREFINISHED



**FD30/FD60 FIRE DOOR  
COMMERCIAL WHITE**  
WHITE PRIMED



**FD30/FD60 FIRE DOOR  
WALNUT DEKORDOR**  
FOILED FINISH



**FD60 FIREDOOR  
PLYWOOD PAINT GRADE**  
UNFINISHED & SANDED



FD60 FIRE FRAME



FD30 FIRE FRAME

# FIRE DOOR GLASS OPTIONS

MODEL	G/WIRE FD30	CLEAR FD30	G/WIRE FD60	CLEAR FD60
DFG56	X	X	X	X
DFG34	X	X	X	X
DFG01	X	X	X	X
DFG41		X		
DFG20		X		
DFG75		X		

GLASS FIRE  
DOORS ARE  
AVAILABLE IN  
THE FOLLOWING  
FINISHES



OAK EBONY



OAK WHITE



OAK MOCHA



OAK PORPOISE

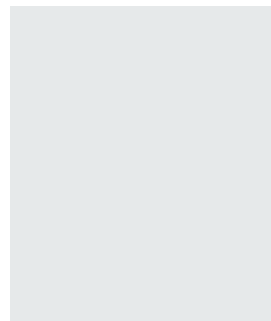

WHITE PRIMED



OAK



WALNUT DEKORDOR



DFG56



DFG34

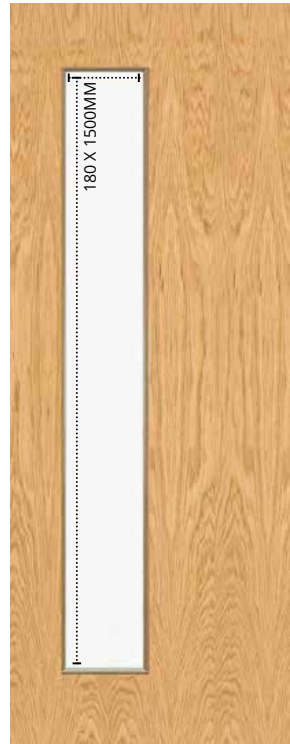

DFG01

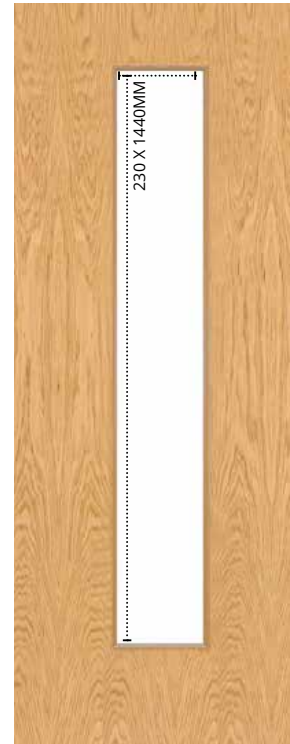

DFG41



DFG20

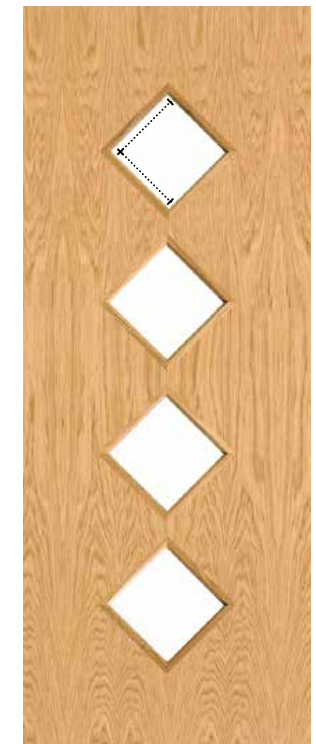

DFG75



**VICAIMA** are European leaders in fire doors and their reputation has been built on quality of product. All Vicaima doors are backed up by certification from BWF Certifire and BM Trada Q mark and by fully accredited Fire Test Assessment reports. Uniquely, Vicaima fire doors can be cut for vision panels as they have a solid chipboard core, unlike many competitors which have semi-solid cores. All Vicaima doors are FSC® certified as standard. FD30 Doors with glass are 44mm with 7mm glass and the FD60 doors are 54mm with 10mm glass.

# WHITE PRIMED

## SKIRTING & ARCHITRAVE

White primed skirting and architrave continue to grow in popularity, allowing for customised finishes. This range can be used to match our white primed doors or will also complement our oak and walnut door range. Our profiles are made from moisture-resistant mdf. All our white primed mdf profiles are FSC® certified.



144mm White  
**MOULDED**  
Skirting Primed



144mm White  
**CHAMFERED**  
Skirting Primed



144mm White  
**SHAKER**  
Skirting Primed



144mm White  
**CONTEMPORARY**  
Skirting Primed



180/210mm White  
**VICTORIAN**  
Skirting Primed



180mm White  
**GRANGE**  
Skirting Primed



69/94mm White  
**MOULDED**  
Architrave Primed



78/94mm White  
**CHAMFERED**  
Architrave Primed



94mm White  
**SHAKER**  
Architrave Primed



94mm White  
**CONTEMPORARY**  
Architrave Primed



94mm White  
**VICTORIAN**  
Architrave Primed



94mm White  
**GRANGE**  
Architrave Primed



WHITERIVER WHITE  
PRIMED MOULDED



WHITERIVER WHITE  
PRIMED CHAMFERED



WHITERIVER WHITE  
PRIMED SHAKER

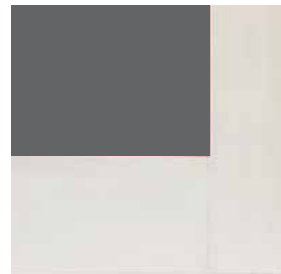

WHITERIVER WHITE  
PRIMED CONTEMPORARY



WHITERIVER WHITE  
PRIMED VICTORIAN



WHITERIVER WHITE  
PRIMED GRANGE



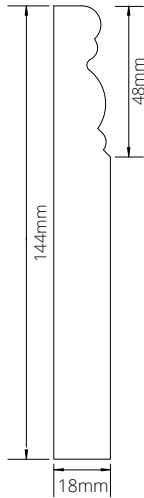

**MOULDED SKIRTING**  
144(H) x 18(W) x 4200mm(L)

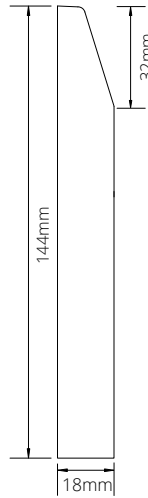

**CHAMFERED SKIRTING**  
144(H) x 18(W) x 4200mm(L)

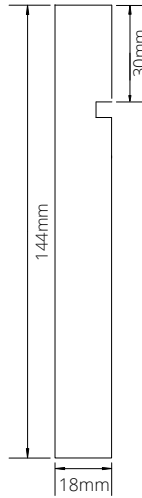

**SHAKER SKIRTING**  
144(H) x 18(W) x 4200mm(L)

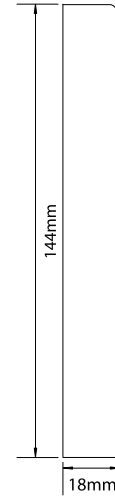

**CONTEMPORARY SKIRTING**  
144(H) x 18(W) x 4200mm(L)

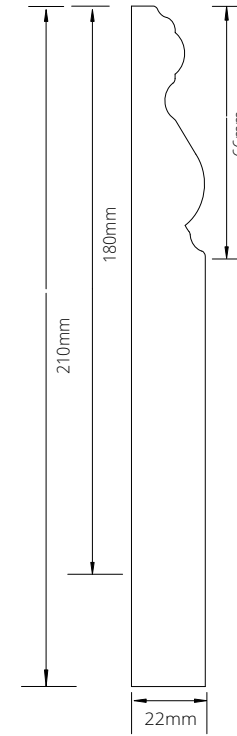

**VICTORIAN SKIRTING**  
180/210(H) x 22(W) x 4200mm(L)

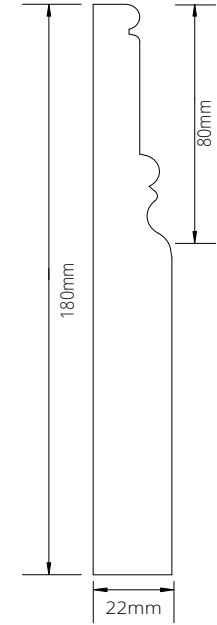

**GRANGE SKIRTING**  
180(H) x 22(W) x 4200mm(L)

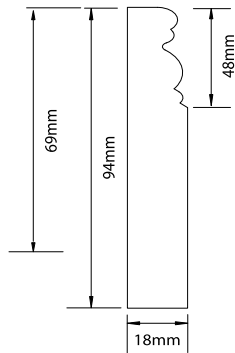

**MOULDED ARCHITRAVE**  
69/94(H) x 18(W) x 2200mm(L)

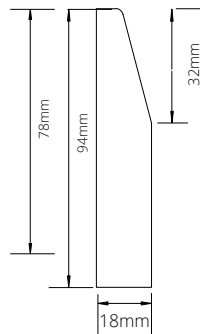

**CHAMFERED ARCHITRAVE**  
78/94(H) x 18(W) x 2200mm(L)

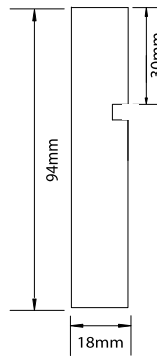

**SHAKER ARCHITRAVE**  
94(H) x 18(W) x 2200mm(L)

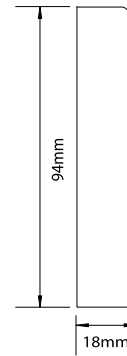

**CONTEMPORARY ARCHITRAVE**  
94(H) x 18(W) x 2200mm(L)

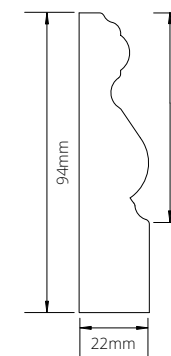

**VICTORIAN ARCHITRAVE**  
94(H) x 18(W) x 2200mm(L)

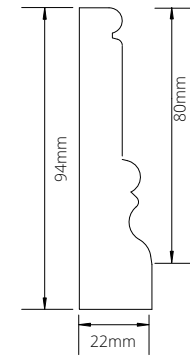

**GRANGE ARCHITRAVE**  
94(H) x 22(W) x 2200mm(L)



**144MM PRE-FINISHED  
CONTEMPORARY PAINTED  
GREY SKIRTING**  
144 X 18 X 4200MM



**94MM PRE-FINISHED  
CONTEMPORARY PAINTED  
GREY ARCHITRAVE**  
94 X 18 X 2200MM

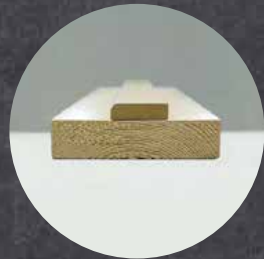

**WHITE PRIMED FRAME WITH STOP**  
108/133 X 30MM



**WHITE PRIMED T-LIPPING**  
22 X 55MM

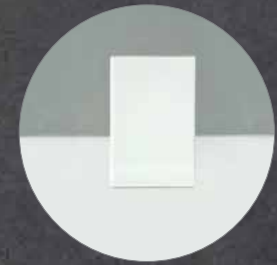

**104 X 25MM PLINTH BLOCKS**  
88/104 X 150 X 25MM

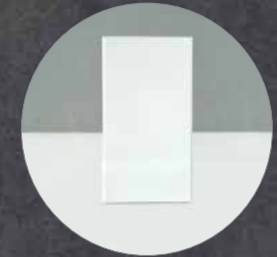

**104 X 30MM PLINTH BLOCKS**  
104 X 190 X 30MM



**WHITE PRIMED HOCKEY STICK**  
32 X 18 X 2195MM



**WINDOW BOARD**  
25 X 244/294 X 3660MM

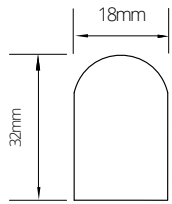

**PRIMED HOCKEY STICK**  
32 x 18 x 2195mm

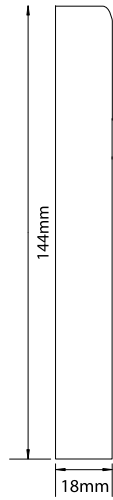

**CONTEMPORARY GREY SKIRTING**  
144(H) x 18 x 4200mm



150(h) x 25(d) x 88mm(w)

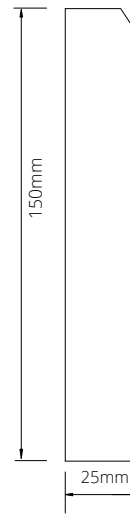

150(h) x 25(d) x 104mm(w)

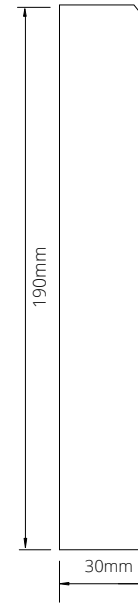

190(h) x 30(d) x 104mm(w)

**PLINTH BLOCKS**

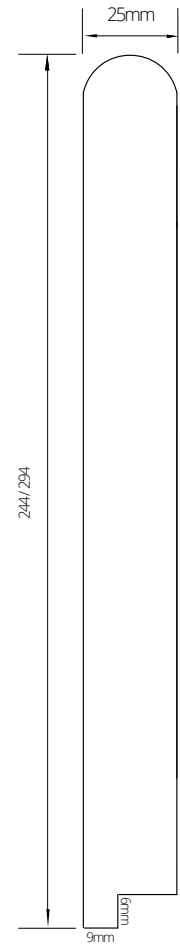

244/294

**WINDOW BOARD**  
244/294 x 25 x 3660mm

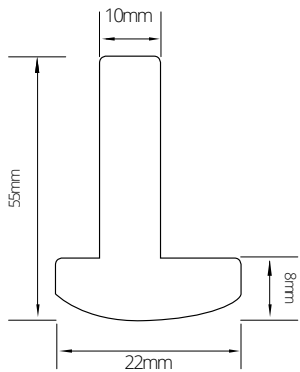

**T-LIPPING DOOR DIVIDER**  
55 x 22

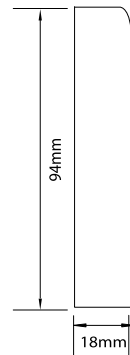

**CONTEMPORARY GREY ARCHITRAVE**  
94x 18 x 2200mm

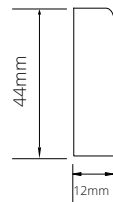

**DOOR STOP**  
44 x 12 x 2070mm

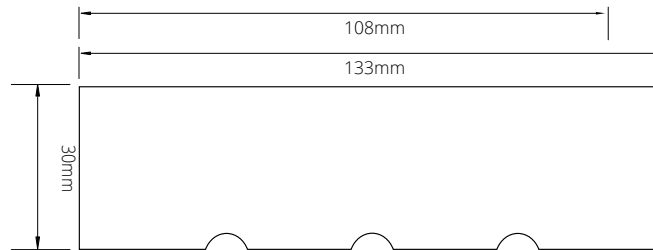

**PRIMED FRAME**  
108/133 x 30mm

# OAK & WALNUT

## SKIRTING & ARCHITRAVE

Oak mouldings specially designed with a mixed core to ensure a perfect style match with oak doors. Pre-finished to a very high standard, providing a quality and durable closed pore finish. Walnut mouldings are designed with a mixed core to ensure a perfect match with walnut doors.

BY WHITERIVER



119mm Oak  
**MOULDED**  
Skirting Varnished

144mm Oak  
**MOULDED**  
Skirting Varnished

144mm Oak  
**CONTEMPORARY**  
Skirting Varnished

144mm Oak  
**CHAMFERED**  
Skirting Varnished

144mm Walnut  
**CONTEMPORARY**  
Skirting Varnished

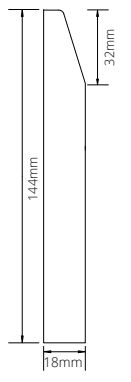
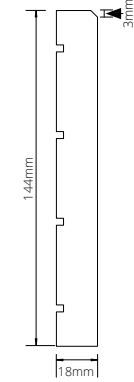
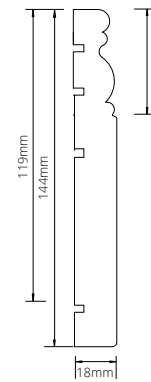

**MOULDED**  
**SKIRTING**  
119/144 x 18 x 3600mm

**CONTEMPORARY**  
**SKIRTING**  
144 x 18 x 3600mm

**CHAMFERED**  
**SKIRTING**  
144 x 18 x 3600mm



69mm Oak  
**MOULDED**  
Architrave Varnished

94mm Oak  
**MOULDED**  
Architrave Varnished

78mm Oak  
**CONTEMPORARY**  
Architrave Varnished

78mm Oak  
**CHAMFERED**  
Architrave Varnished

78mm Walnut  
**CONTEMPORARY**  
Architrave Varnished

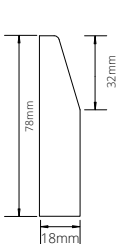
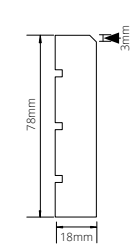
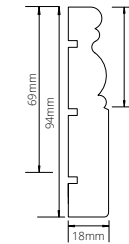

**MOULDED**  
**ARCHITRAVE**  
69/94 x 18mm

**CONTEMPORARY**  
**ARCHITRAVE**  
78 x 18mm

**CHAMFERED**  
**ARCHITRAVE**  
78 x 18mm



WHITERIVER OAK  
MOULDED (119/69mm)



WHITERIVER OAK  
MOULDED (144/94mm)



WHITERIVER OAK  
CHAMFERED



WHITERIVER OAK  
OAK CONTEMPORARY



WHITERIVER WALNUT  
CONTEMPORARY

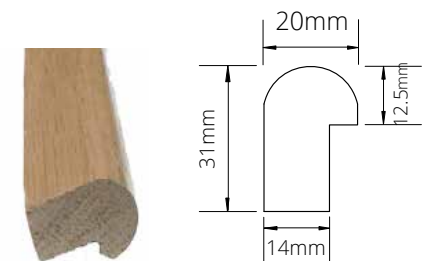

**OAK HOCKEY STICK**  
20mm x 31mm

## ENGINEERED DOOR FRAME, STOP & LINER BY WHITERIVER

Door frame is an essential component in the installation of doors. Our door frames come prefinished in both oak and walnut engineered mixed hardwood core to match your range of Whiteriver or Seadec Doors. Each door frame set includes matching door stop.



**105/133/144MM  
OAK DOOR FRAME**  
Varnished (Whiteriver)



**133MM  
WALNUT DOOR FRAME**  
Varnished (Whiteriver)

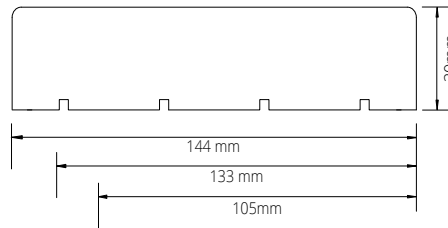

**DOOR FRAME**  
105mm/133mm/144mm x 30mm



**44MM OAK  
DOOR STOP**  
Varnished



**44MM OAK  
DOOR LINER**  
Varnished



**94MM OAK  
DOOR LINER**  
Varnished

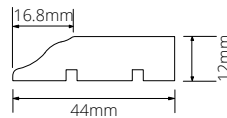

**DOOR STOP**  
12 x 44mm (included in door frame set)

## ENGINEERED DOOR FRAME & STOP BY SEADec

Seadec oak door frame is manufactured using choice real wood veneers combined with an engineered core. The oak frame is factory finished with a high quality PU finish.



**133MM OAK DOOR FRAME  
WITH STOP**  
Varnished (Seadec)

## T-LIPPINGS



**SOLID OAK T-LIPPING**  
22 X 55MM



**SOLID WALUT T-LIPPING**  
22 X 55MM



# MDF VENEERED MOULDINGS



140MM OAK  
**MOULDED SKIRTING**  
VARNISHED



140MM OAK  
**CHAMFERED SKIRTING**  
VARNISHED



140MM OAK  
**SHAKER SKIRTING**  
VARNISHED



140MM WALNUT  
**MOULDED SKIRTING**  
VARNISHED



140MM WALNUT  
**CHAMFERED SKIRTING**  
VARNISHED



80MM OAK  
**MOULDED  
ARCHITRAVE**  
VARNISHED



80MM OAK  
**CHAMFERED  
ARCHITRAVE**  
VARNISHED



80MM OAK  
**SHAKER STYLE  
ARCHITRAVE**  
VARNISHED



80MM WALNUT  
**MOULDED  
ARCHITRAVE**  
VARNISHED



80MM WALNUT  
**CHAMFERED  
ARCHITRAVE**  
VARNISHED

# DOOR SIZES & SPECS

If you are buying replacement doors, DO NOT measure the existing door. You must always base your measurements on the door frame.

Door width: Take three measurements inside the door frame - at the top, middle and bottom. The widest measurement determines the width of the door. Door height: Measure the inside of each vertical side of the frame. The longest length determines the height required. Remember to make allowance for any floor covering.

REGENCY	80X34	80X32	78X30	78X28	78X26	78X24	78X33	78X27
	2032 x 864	2032 x 813	1981 x 762	1981 x 711	1981 x 660	1981 x 610	1981 x 838	1981 x 686
6P Woodgrain	X	X	X	X	X	X		
4P Woodgrain	X	X	X	X	X	X		
2P Woodgrain	X	X	X	X	X	X		
2P/2P Glazed Woodgrain	X	X	X					
2P Smooth	X	X	X	X	X	X		
6P Smooth	X	X	X	X	X	X		
RED PINE	80X34	80X32	78X30	78X28	78X26	78X24	78X33	78X27
Westport 6P	X	X	X	X	X	X		
Kingscourt 4P	X	X	X	X	X	X		
Belfast 4P Curved	X	X	X	X	X	X		
Waterford 2P/2G Unglazed	X	X	X	X				
Longford 2P/2G Unglazed	X	X	X	X				
Waterford Glass 1-6	X	X	X	X				
Longford Glass 3-6	X	X	X	X				
Waterford Clear Glass	X	X	X	X				
Longford Clear Glass	X	X	X	X				
GREY EXCLUSIVE RANGE	80X34	80X32	78X30	78X28	78X26	78X24	78X33	78X27
Genoa	X	X	X	X	X	X	X	X
Milano	X	X	X	X	X	X	X	X
Torino	X	X	X				X	
Napoli Clear & Frosted	X	X	X				X	
AMERICAN WALNUT	80X34	80X32	78X30	78X28	78X26	78X24	78X33	78X27
Hampton 1P	X	X	X	X	X	X	X	X
Cheshire 1P Glazed	X	X	X	X			X	
Augusta 4P	X	X	X	X	X	X	X	
Columbus 4P Glazed	X	X	X				X	
Arizona 9P Glazed	X	X	X				X	
Kingscourt 4P	X	X	X	X	X	X	X	X
Waterford 2P/2G Unglazed	X	X	X				X	
Waterford 2P/2G Glazed 1-6	X	X	X				X	
Waterford 2P/2G Clear Glass	X	X	X				X	

WHITE PRIMED	80X34	80X32	78X30	78X28	78X26	78X24	78X33	78X27
	2032 x 864	2032 x 813	1981 x 762	1981 x 711	1981 x 660	1981 x 610	1981 x 838	1981 x 686
Kingscourt 4P	X	X	X	X	X	X	X	X
Waterford 2P/2G Unglazed	X	X	X				X	
Waterford Glass 1-6	X	X	X				X	
Cambridge 4P	X	X	X	X	X	X	X	X
Oxford 2P/2G Unglazed	X	X	X				X	
Oxford 2P/2G Glass 3	X	X	X				X	
Nevada Sheeted	X	X	X	X	X	X	X	X
Arizona 9P Glazed	X	X	X	X			X	
Hampton 1P	X	X	X	X	X	X	X	X
Cheshire 1P Glazed	X	X	X	X	X	X	X	
Augusta 4P	X	X	X	X	X	X	X	X
Columbus 4P Glazed	X	X	X				X	
Kingston Bolection 2P	X	X	X	X	X	X	X	X
Albany Bolection 2P Glazed	X	X	X				X	
Trenton 1P Stepped	X	X	X	X	X	X	X	X
Madison 1P Stepped Glazed	X	X	X				X	
Nevada Half Glass	X	X	X				X	
Cheshire Frosted Clear Border	X	X	X	X			X	
Sussex Plank	X	X	X	X	X	X	X	X
Somerset Plank Glazed	X	X	X				X	
OAK BOLECTION	80X34	80X32	78X30	78X28	78X26	78X24	78X33	78X27
Belfast 4P Curved	X	X	X	X	X	X	X	
Longford 2P/2G Unglazed	X	X	X				X	
Longford 2P/2G Glazed 3-6	X	X	X				X	





# CARE AND INSTALLATION GUIDE

*For fire doors please refer to their certification for fitting instructions.*

## BEFORE YOU START

Your Seadec door and accessories (frames, skirting & architrave) must be stored flat on a clean, dry and level surface, with level battens to allow the air to circulate. To allow your door and accessories to acclimatise to their environment, they should be left in the house, for at least 7 days, with the heating and environment regulated per installation guidelines below. Environmental and door moisture readings should be taken prior to hanging and recorded, to ensure that the doors and the environment are in correct. Failure to allow the doors to acclimatise may cause excessive expansion and contraction leading to splitting and warping and will void the guarantee.

Unfinished or primed doors must be sealed and painted immediately after hanging with at least three coats applied, also the top and bottom of door must be painted the same way to ensure they are fully sealed.

Seadec doors and accessories must not be installed into a house that is freshly plastered, tiled or painted, it is crucial that building is properly dried out and that heating and humidity in building are stable before doors or accessories are brought on site or fitted, please ensure the building meets with the moisture and temperature guidelines below. Should a door require alteration, cutting or planing, it must be immediately varnished with three coats, otherwise it will absorb moisture which can lead to problems such as warping or splitting. Seadec doors may be altered by up to 10mm off the top and bottom and up to 7mm on each side only. However, any alteration of a Seadec door will void the warranty.

Where doors are manufactured with solid timber, there has to be a consideration that timber will adjust itself to the environment. **Therefore , please note that there is a BS standard of +/- 4mm of a bow tolerance on the length of a door.**

## PACKAGING

Prior to removing the packaging, ensure that the doors, frames, skirting and architrave are the correct size and colour. Prior to removing from packaging, inspect each door, frame and piece of skirting and architrave in daylight for any visible faults or defects, also check the colour structure and finish. Once any Seadec product is removed from its packaging, it is deemed to be acceptable and cannot be returned for any visible faults or defects. Please note: Timber is a natural product and may show variations in colour or graining.

## FRAMES

Ensure that the frames where the doors are being fitted into are plumb, and that the doors are not strained to fit into uneven framing. Fit 3 hinges on all doors at all times.

## INSTALLATION AREA MOISTURE

The area of installation (the concrete floor and walls) must not be over 4% moisture content. This can be tested with an appropriate moisture meter. The temperature be between 18° - 22° and the relative humidity between 40% – 60%, while the doors are being stored, before, during and after the installation. Do not bring doors, skirting or architrave into a house or site which does not meet the above conditions.

## LOCKS AND HANDLES

When fitting a lock or a handle, it is best not to fit the lock where the stile (uprights) meets the rail (horizontals) as this will weaken the structure of the door.

## ROOM CONDITIONS

Timber likes pleasant room conditions, just like us, a room temperature of approx 20°C and humidity of about 50% – 60%.

## CLEANING

- Use a clean dry cloth to clean the doors.
- Furniture polish may also be used.
- Never use wax or aggressive detergents or products containing ammonia or silicates on Seadec products.
- Our frosted medical glass should be cleaned with a dry, soft cotton cloth. Do not use damp cloths.

## PROTECTING YOUR SEADEC PRODUCTS

Ensure that rooms are well ventilated, particularly in rooms where there are large changes in temperature and moisture. In the event of a proven manufacturing defect, Seadec or the Seadec retailer's total liability shall under no circumstances exceed the value of the defective product. Seadec or the Seadec retailer's shall not in any way be responsible for any additional consequential costs or losses. If you are unclear of any of the above instructions, contact your local Seadec supplier.



## HOW TO **FINISH SEADEC** WHITE PRIMED PRODUCTS

Preparation is key to any project no matter how big or small. Firstly select a good, dry, clean space to lay the product down flat prior to finishing with sufficient room to work around and where the product can be left to to dry. As with all painting projects adequate ventilation during painting and drying is essential.

The next step is to spend a few minutes checking for any imperfections that may require filling and fine sanding - this is key to achieving a flawless finish and a vital step in the process.

Once the surface is clean and dust free, apply a water based undercoat which will allow better adhesion for your chosen finish.

When the undercoat is dry, give the surface a light sanding before applying your chosen oil or water based finishing coat.

Paint manufacturer's drying guidelines will vary therefore it is important follow them. While "touch dry" may allow you to handle the product it may not be sufficiently dry to begin fitting hinges and handles until full recommended drying time is completed.

**seadec**  
doors for living...



[www.wrg.ie](http://www.wrg.ie)